

# LAB SMALL

MATERIALE: CORIAN

PILETTA: UP & DOWN - IN TINTA

PESO NETTO: 85 Kg

PESO LORDO: 115 Kg

DIMENSIONE IMBALLO: VARIABILE

CAPACITÀ: 230 LITRI

REGOLAZIONE PIEDINI: 10 mm

DIAMETRO SCARICO: 4 cm

TOLLERANZA: ± 5 mm

**PILETTA  
E SIFONE  
INCLUSI**



**SENZA  
TROPPO  
PIENO**

**NO TUBO  
CORRUGABILE**

## POZZETTO OBBLIGATORIO

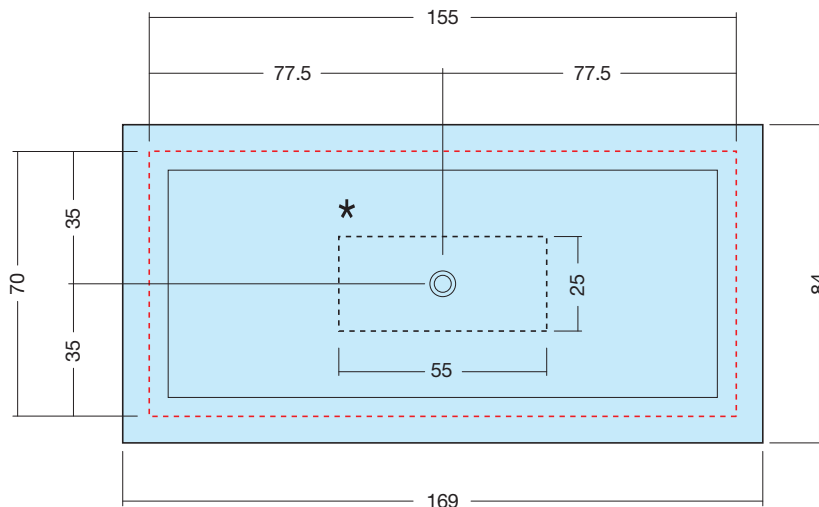
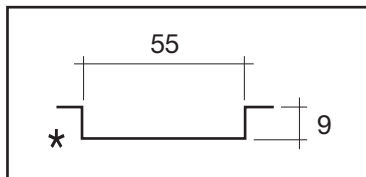

## ARTICOLI

LABS1L



LABS2L



LABS3L



LABS4L

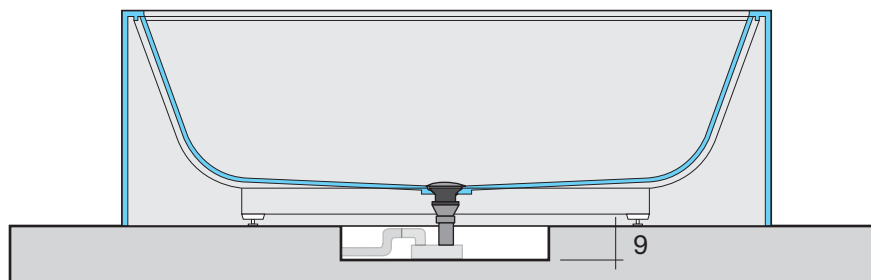
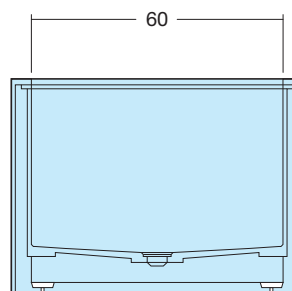
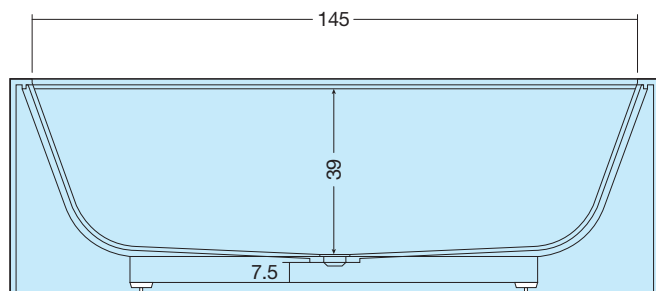

# DISENIA

Disenia srl  
via A. Carpenè, 21  
33070  
Brugnera (PN)  
Italy

**INFO**  
Tel. +39 0434 1822603  
Fax +39 0434 020013  
www.disenia.it  
e-mail: info@disenia.it

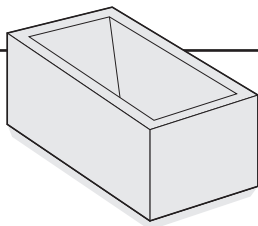

# LAB MEDIUM

MATERIALE: CORIAN

PILETTA: UP & DOWN - IN TINTA

PESO NETTO: 90 Kg

PESO LORDO: 120 Kg

DIMENSIONE IMBALLO: VARIABILE

CAPACITÀ: 250 LITRI

REGOLAZIONE PIEDINI: 10 mm

DIAMETRO SCARICO: 4 cm

TOLLERANZA: ± 5 mm

**PILETTA  
E SIFONE  
INCLUSI**



**SENZA  
TROPPO  
PIENO**

**NO TUBO  
CORRUGABILE**

## POZZETTO OBBLIGATORIO

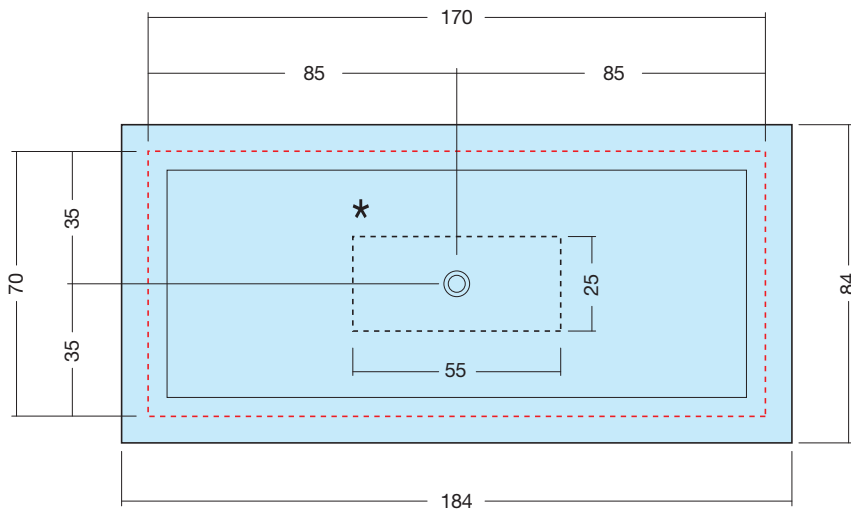
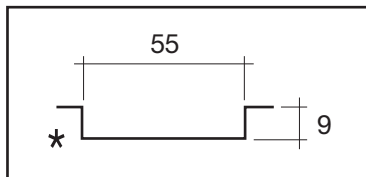

## ARTICOLI

LABS1L



LABS2L



LABS3L



LABS4L

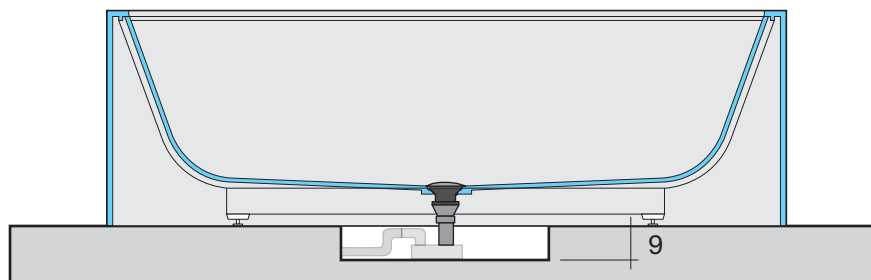
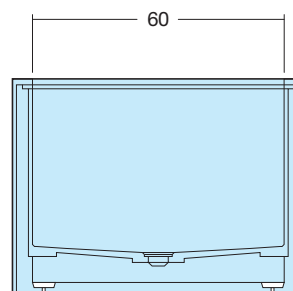
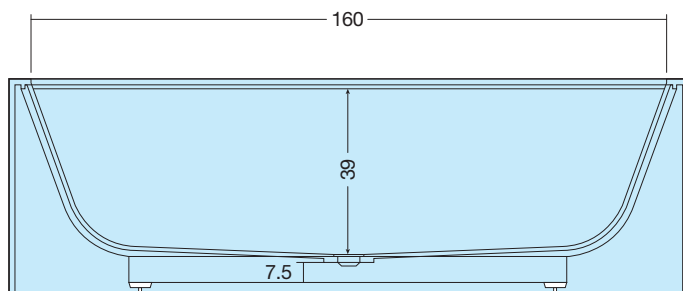

# DISENIA

Disenia srl  
via A. Carpenè, 21  
33070  
Brugnera (PN)  
Italy

**INFO**  
Tel. +39 0434 1822603  
Fax +39 0434 020013  
www.disenia.it  
e-mail: info@disenia.it

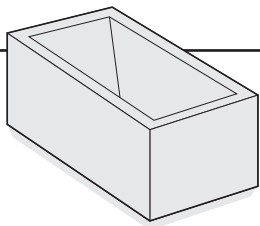

# LAB LARGE

MATERIALE: CORIAN

PILETTA: UP & DOWN - IN TINTA

PESO NETTO: 95 Kg

PESO LORDO: 125 Kg

DIMENSIONE IMBALLO: VARIABILE

CAPACITÀ: 270 LITRI

REGOLAZIONE PIEDINI: 10 mm

DIAMETRO SCARICO: 4 cm

TOLLERANZA:  $\pm 5$  mm

**PILETTA  
E SIFONE  
INCLUSI**



**SENZA  
TROPPO  
PIENO**

**NO TUBO  
CORRUGABILE**

## POZZETTO OBBLIGATORIO

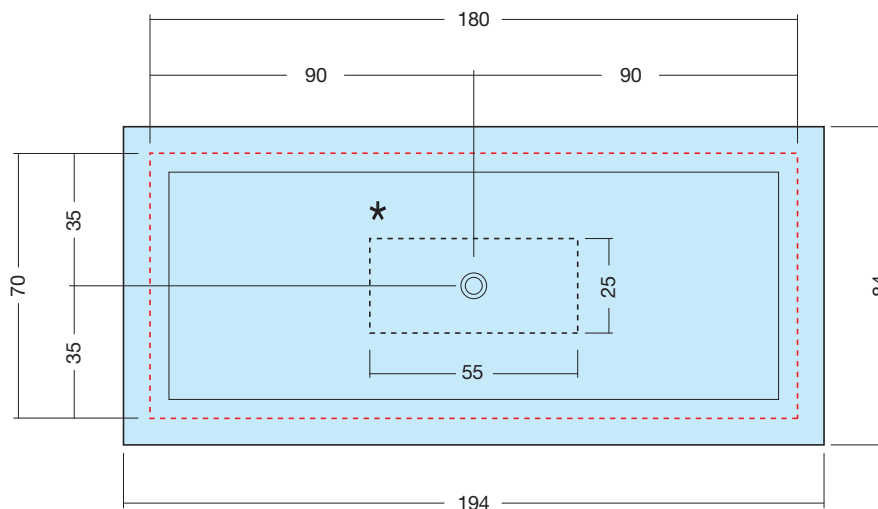
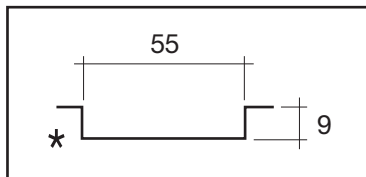

## ARTICOLI

LABS1L



LABS2L



LABS3L



LABS4L

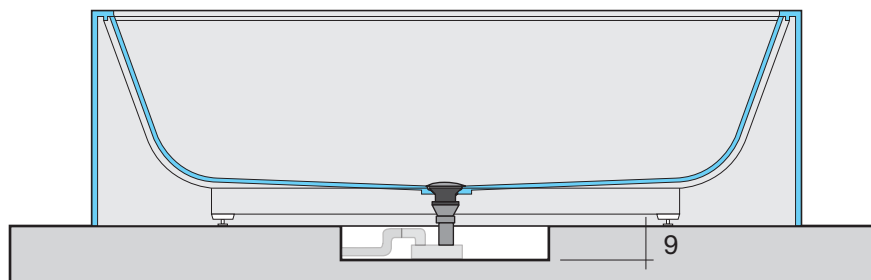
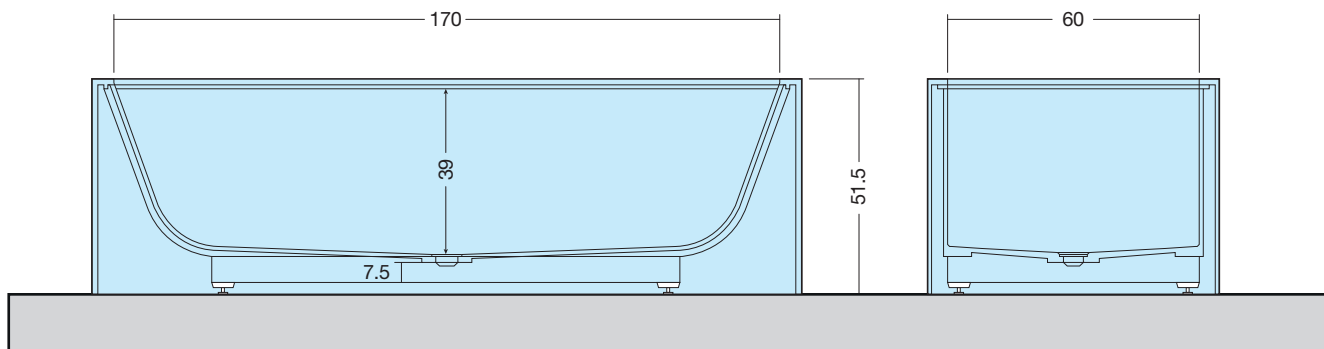

# DISENIA

Disenia srl  
via A. Carpenè, 21  
33070  
Brugnera (PN)  
Italy

**INFO**  
Tel. +39 0434 1822603  
Fax +39 0434 020013  
www.disenia.it  
e-mail: info@disenia.it

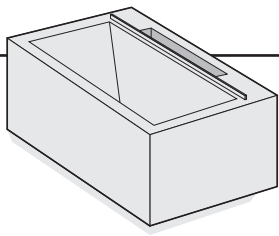

# LAB SMALL CON PORTAOGGETTI

MATERIALE: CORIAN

PILETTA: UP & DOWN - IN TINTA

PESO NETTO: 85 Kg

PESO LORDO: 115 Kg

DIMENSIONE IMBALLO: VARIABILE

CAPACITÀ: 230 LITRI

REGOLAZIONE PIEDINI: 10 mm

DIAMETRO SCARICO: 4 cm

TOLLERANZA: ± 5 mm

**PILETTA  
E SIFONE  
INCLUSI**



**SENZA  
TROPPO  
PIENO**

**NO TUBO  
CORRUGABILE**

## POZZETTO OBBLIGATORIO

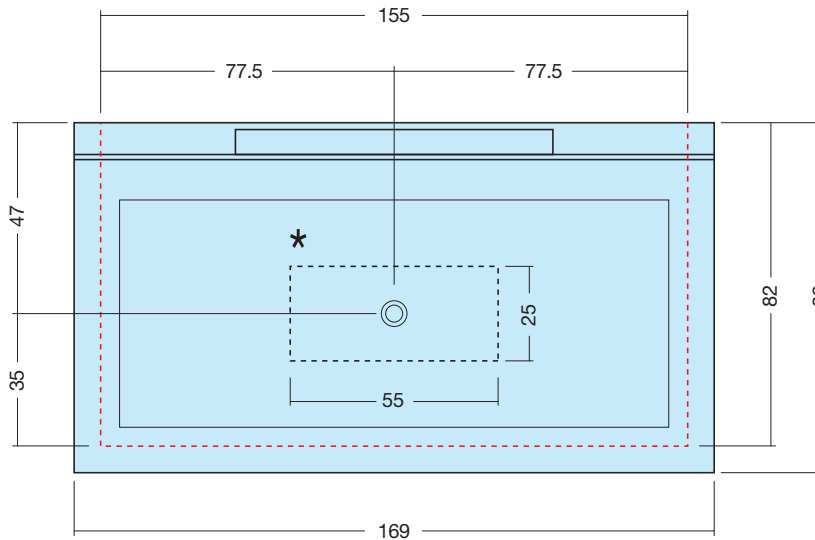
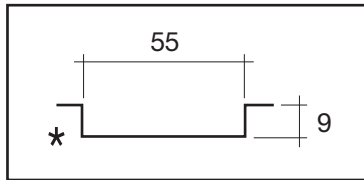

ARTICOLI	
<b>LABS1L</b> 	<b>LABS2L</b> 
<b>LABS3L</b> 	<b>LABS4L</b> 

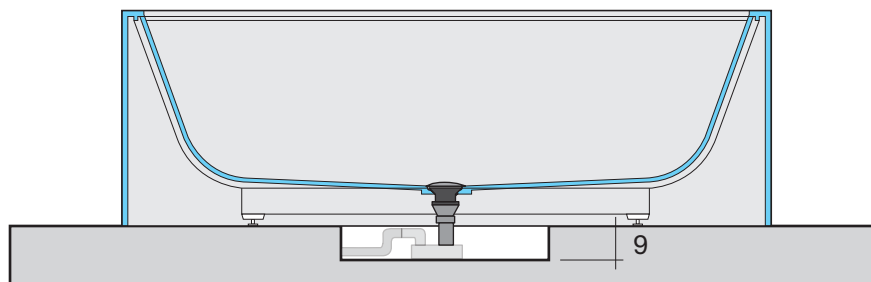
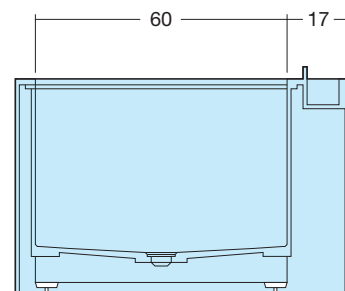
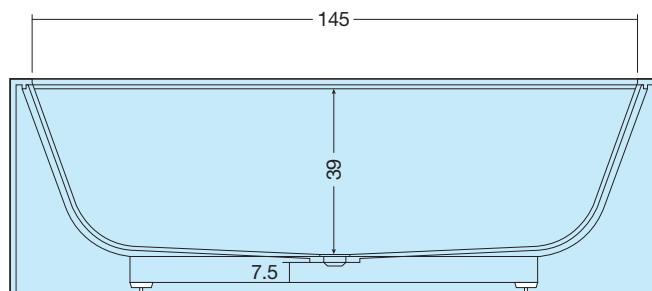

# DISENIA

Disenia srl  
via A. Carpenè, 21  
33070  
Brugnera (PN)  
Italy

**INFO**  
Tel. +39 0434 1822603  
Fax +39 0434 020013  
www.disenia.it  
e-mail: info@disenia.it

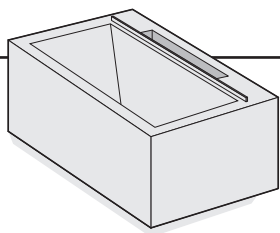

# LAB MEDIUM CON PORTAOGGETTI

MATERIALE: CORIAN

PILETTA: UP & DOWN - IN TINTA

PESO NETTO: 90 Kg

PESO LORDO: 120 Kg

DIMENSIONE IMBALLO: VARIABILE

CAPACITÀ: 250 LITRI

REGOLAZIONE PIEDINI: 10 mm

DIAMETRO SCARICO: 4 cm

TOLLERANZA:  $\pm 5$  mm

## POZZETTO OBBLIGATORIO

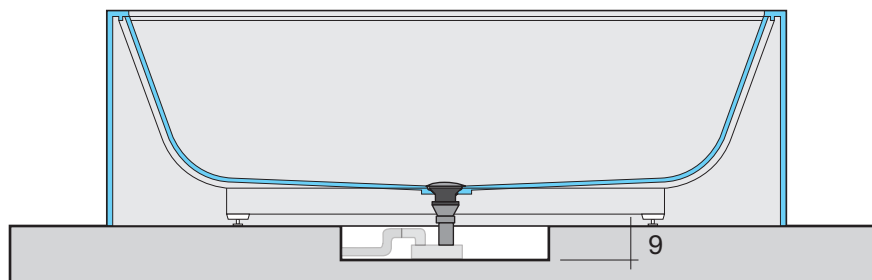
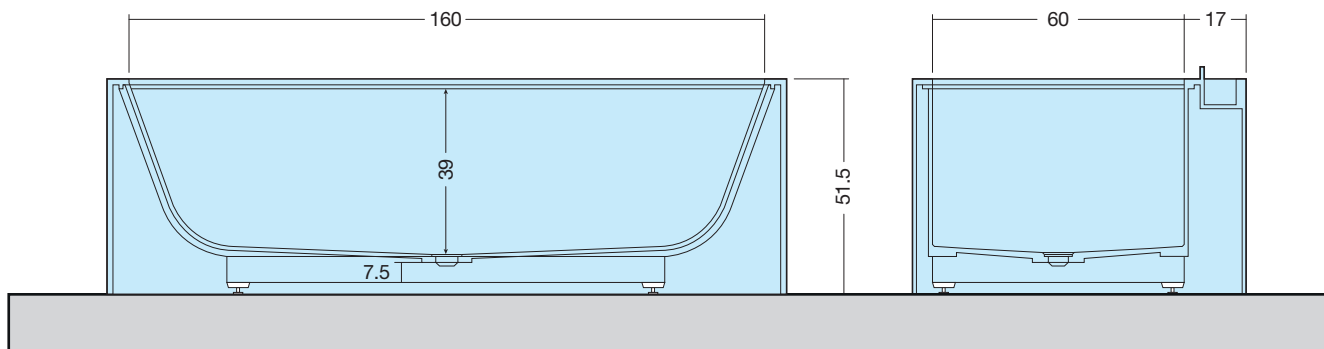
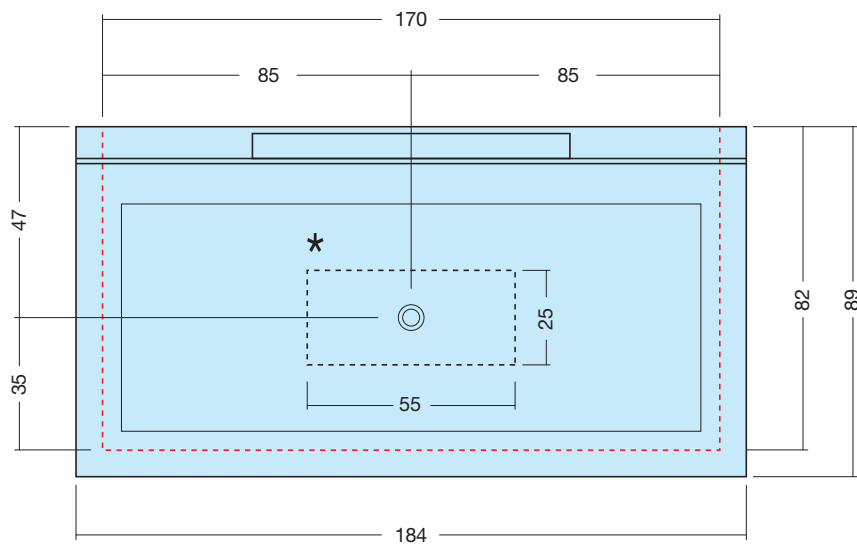
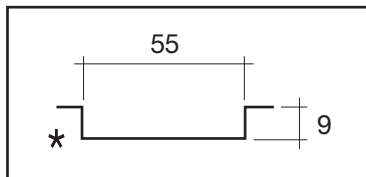

**PILETTA  
E SIFONE  
INCLUSI**



**NO TUBO  
CORRUGABILE**

## ARTICOLI

LABS1L

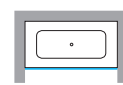

LABS2L

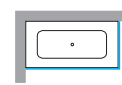

LABS3L



LABS4L



# DISENIA

Disenia srl  
via A. Carpenè, 21  
33070  
Brugnera (PN)  
Italy

**INFO**  
Tel. +39 0434 1822603  
Fax +39 0434 020013  
www.disenia.it  
e-mail: info@disenia.it

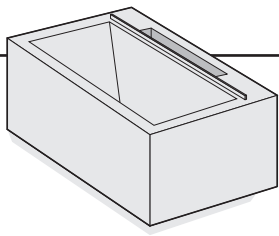

# LAB LARGE CON PORTAOGGETTI

MATERIALE: CORIAN

PILETTA: UP & DOWN - IN TINTA

PESO NETTO: 95 Kg

PESO LORDO: 125 Kg

DIMENSIONE IMBALLO: VARIABILE

CAPACITÀ: 270 LITRI

REGOLAZIONE PIEDINI: 10 mm

DIAMETRO SCARICO: 4 cm

TOLLERANZA: ± 5 mm

**PILETTA  
E SIFONE  
INCLUSI**



**SENZA  
TROPPA  
PIENO**

**NO TUBO  
CORRUGABILE**

## POZZETTO OBBLIGATORIO

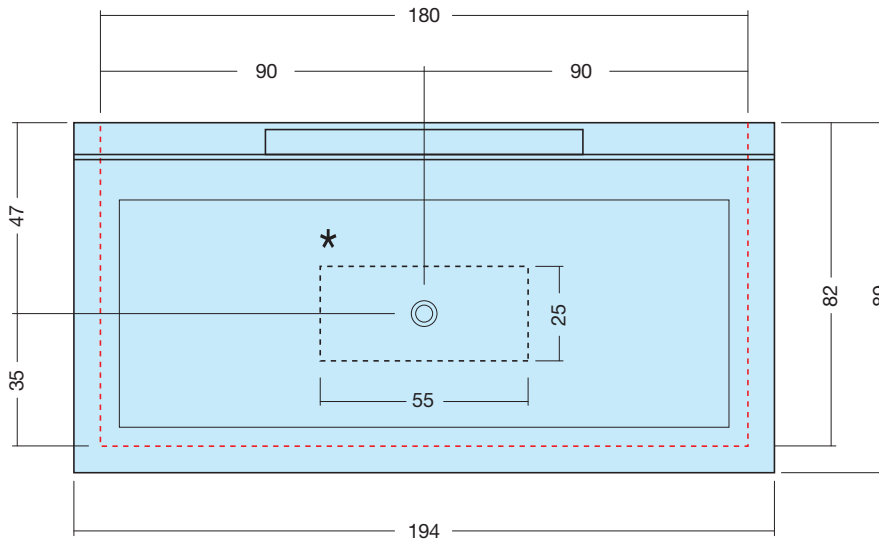
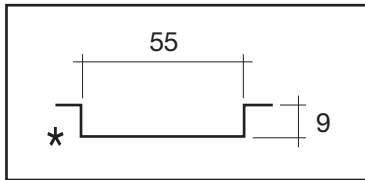

## ARTICOLI

LABS1L

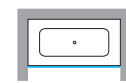

LABS2L

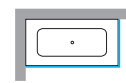

LABS3L

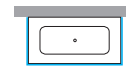

LABS4L

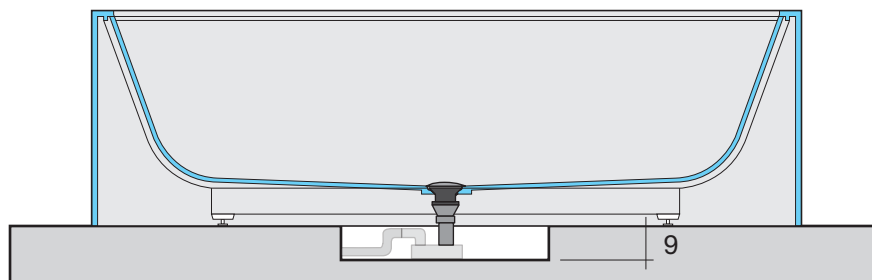
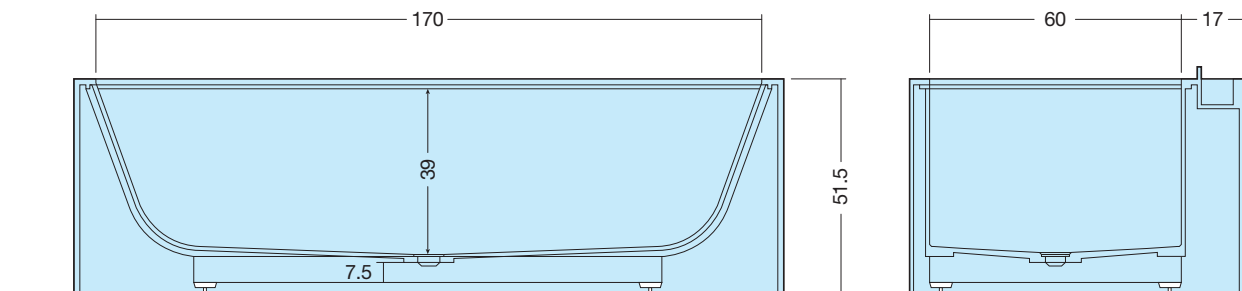
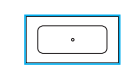

# DISENIA

Disenia srl  
via A. Carpenè, 21  
33070  
Brugnera (PN)  
Italy

**INFO**  
Tel. +39 0434 1822603  
Fax +39 0434 020013  
www.disenia.it  
e-mail: info@disenia.it